

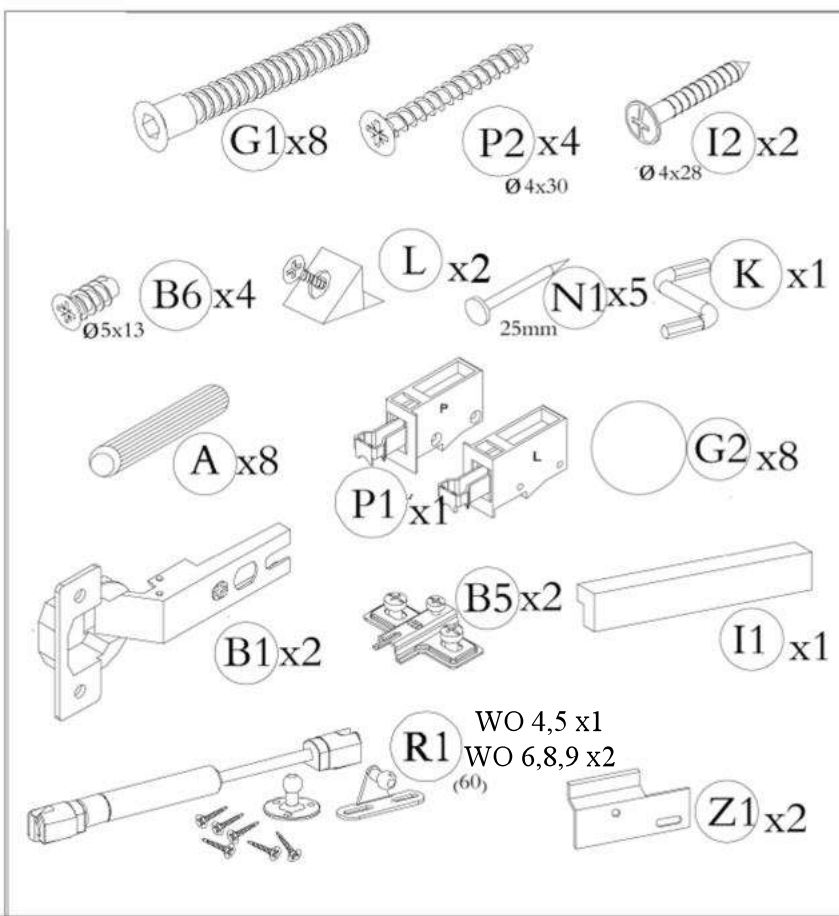

WO 4-9/36

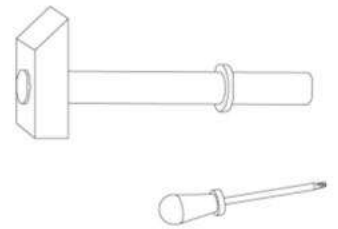

1.

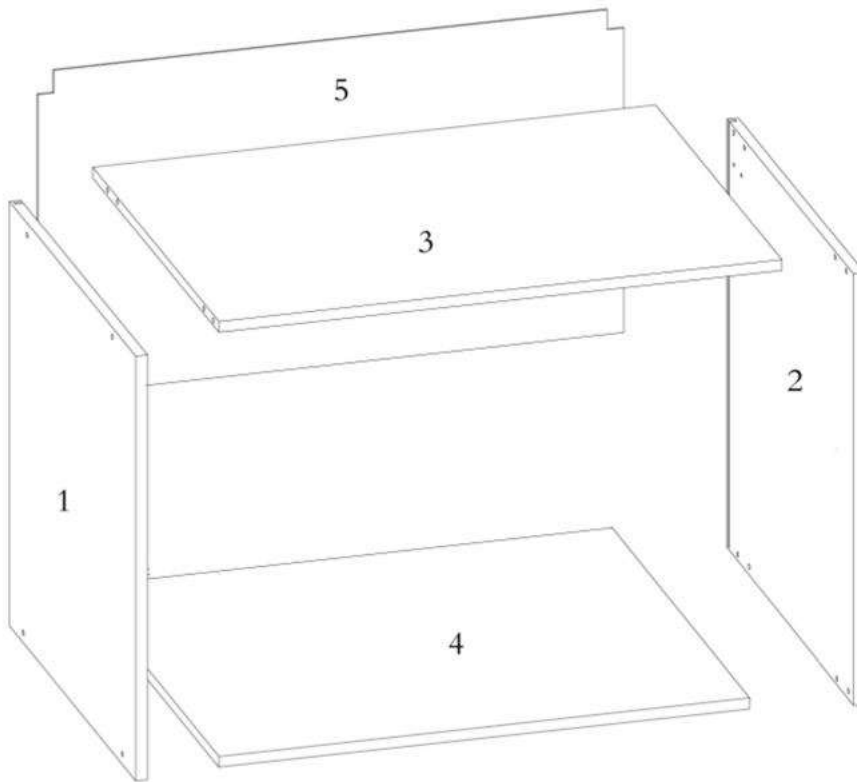

2.

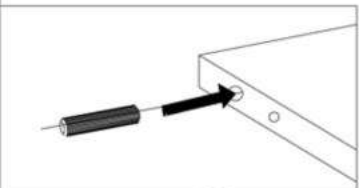
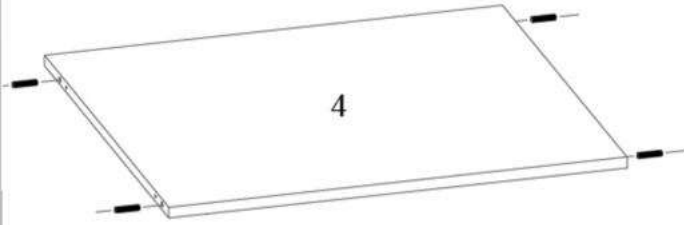
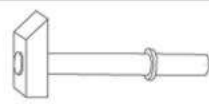
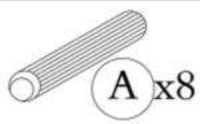

3.

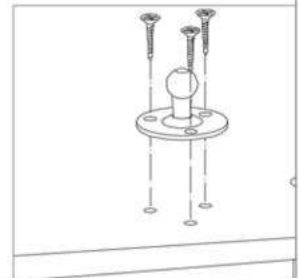
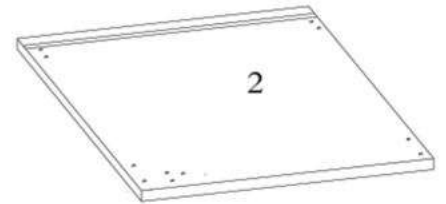
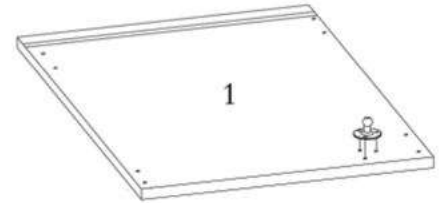
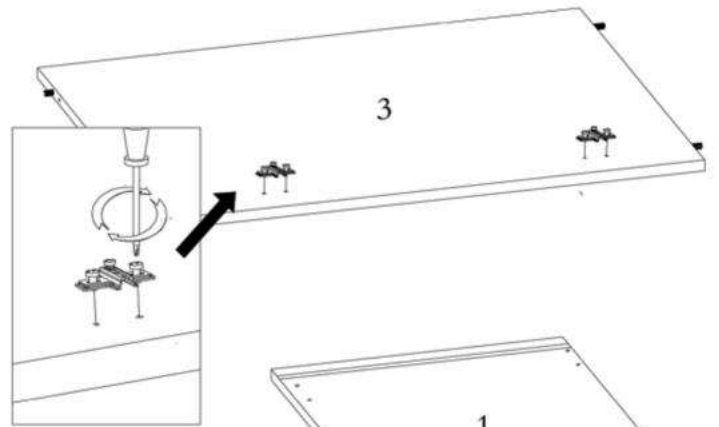

4.1

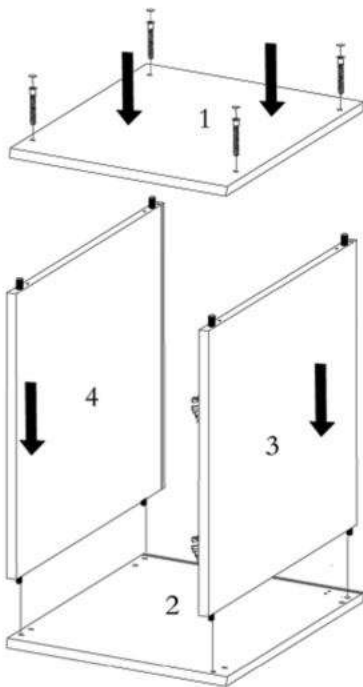

4.2

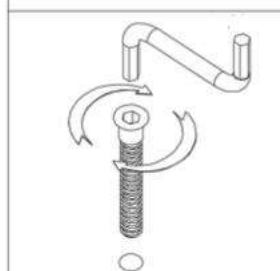
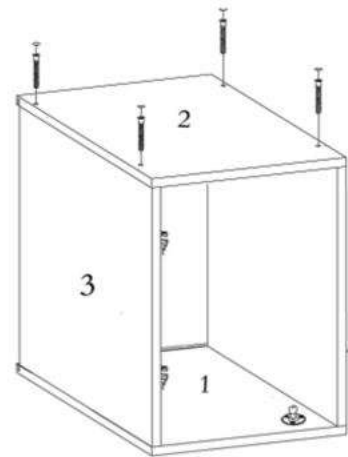

5.

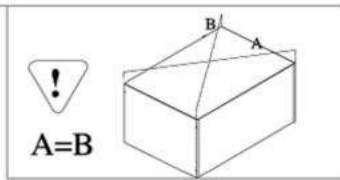
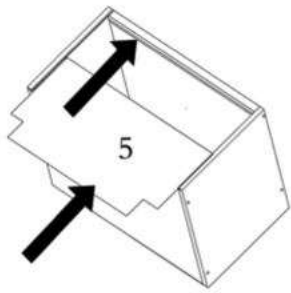

5.1

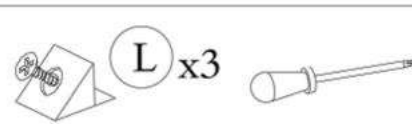

5.2

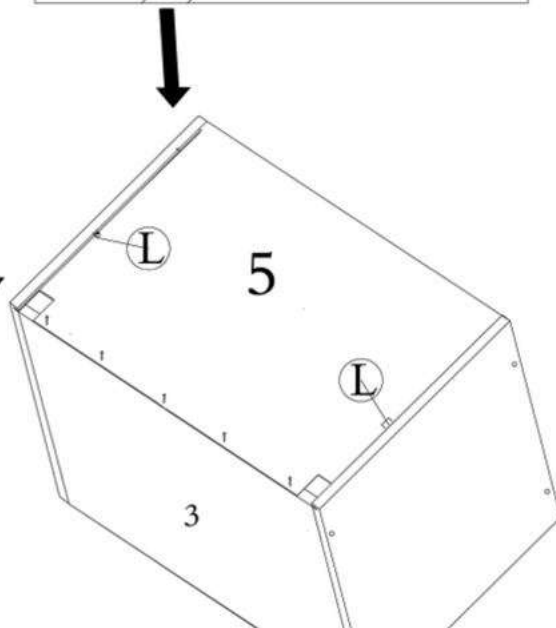
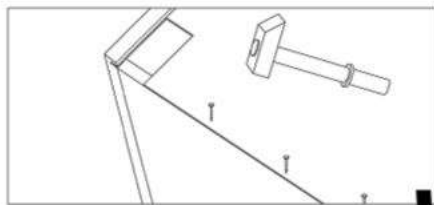
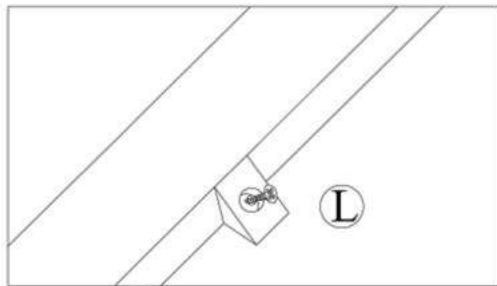

6.

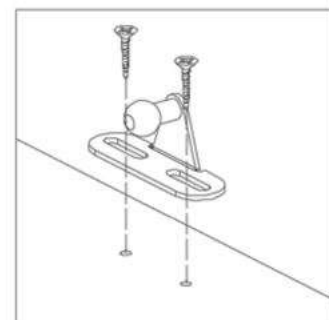
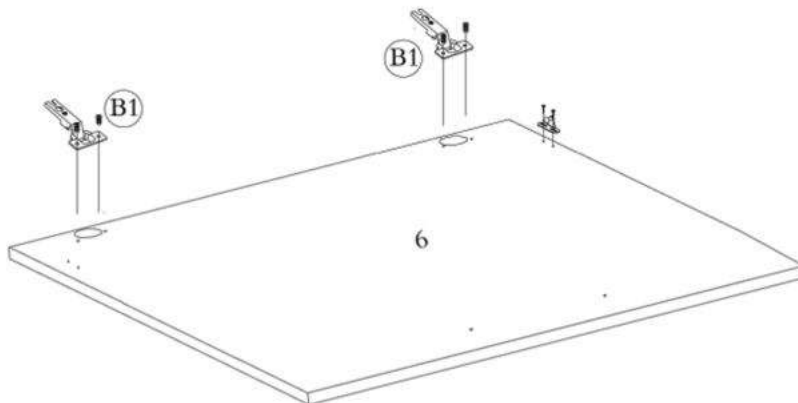
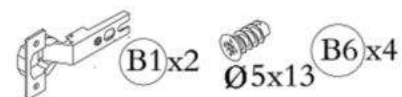
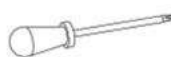

7.

P1 x1

P2 x4
Ø4x30

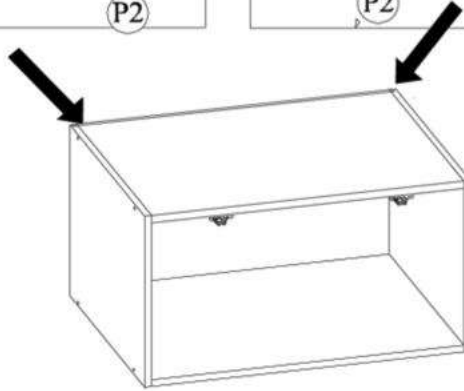
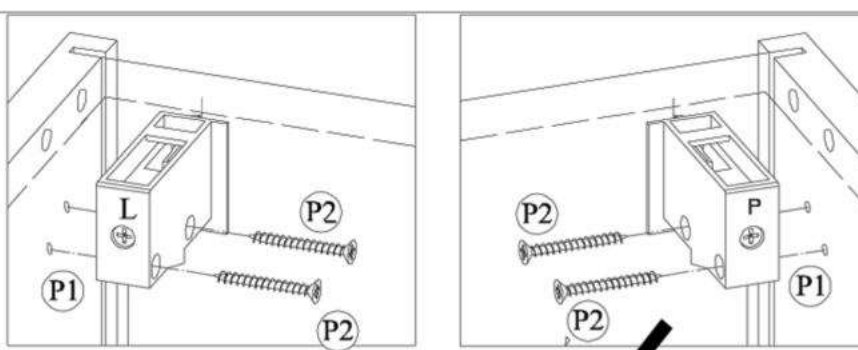

8.1

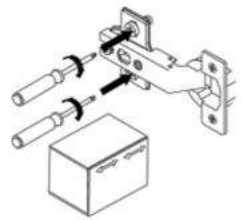
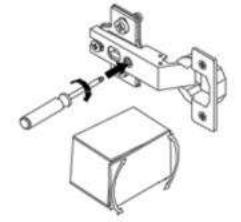
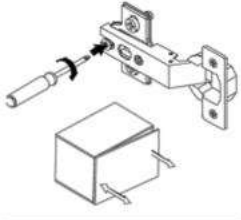

I2 x2
Ø4x28

I1 x1

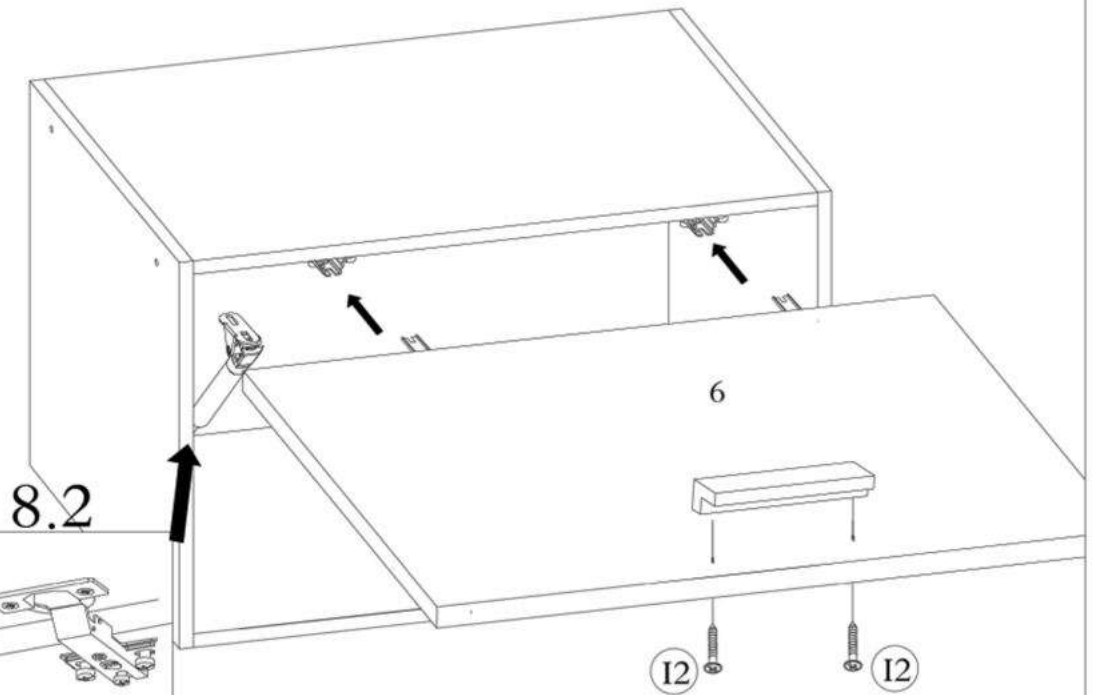

8.2

click!

click!

